

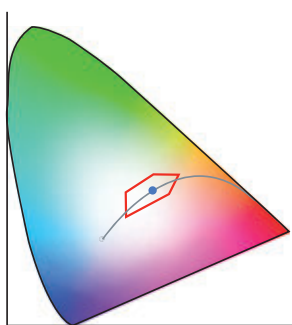

D^{med}® **saturn** LED
LED TREATMENT LIGHTS





-  Black Body Curve
-  EN 60601-2-41
-  optimal light colour temperature

Colour rendering

Accurate colour rendering of the locally lighted body of the patient – no colour contaminations. Ra = 93

This means, for the practitioner, a more detailed recognition of the slightest colour nuances of the tissue. The lighted area appears natural and contrasted. The light is markedly more comfortable to the eye, and all colours are rendered with an absolute accuracy.



No heat radiation

LED light contains almost no infrared radiation, so that the light does not generate heat. Both the practitioner and the patient do not feel any hot spot on the body (due to the light source) – the treated area does not heat up.

Easier working: the humid tissue does not dry out during the treatment.



Optimal working conditions

Often, the luminaire is located close to the head of the physician. Thanks to the cold light, the working conditions are optimal, and do not cause fatigue or headaches because of the heat. The light does not affect the performance of the physician.

Since there is no important generation of heat, no cooling fan is required. This ensures a silent working environment.

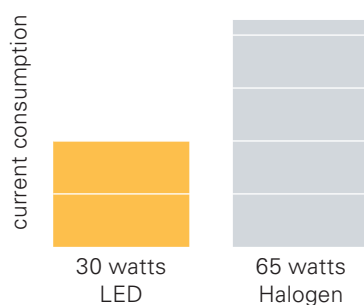

Improved energy efficiency

Notable energy savings thanks to the most up-to-date LED technology: high illuminance with only 30 watts.

With its low requirements, the simple setting of the light intensity ensures a minimised current consumption.

Divergence loss is avoided: LEDs have an oriented light beam. And in addition, the light is focussed by the optics.



Maintenance

The high lifetime of the LEDs ensures an almost maintenance-free operation. No light source replacement is required for the whole service life.

A closed design and the smooth surfaces guarantee a quick cleaning and disinfection. Furthermore, this design prevents the penetration of dust, dirt and liquids. The handle can be sterilised.

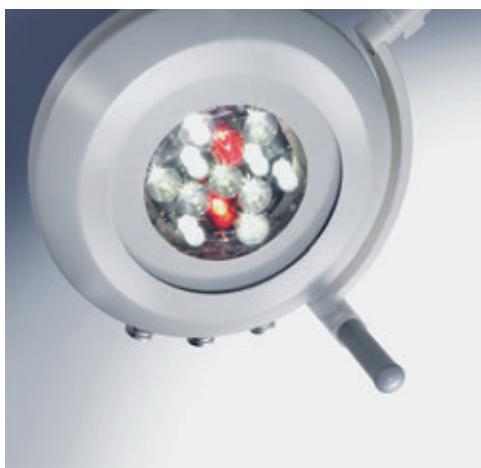

Minimised operating costs

The absence of maintenance work reduces the maintenance costs: no wear parts, no light source replacement.

Universal 100-240 volts transformer: can be used in all countries (specialised commerce).



Comfortable operation

3 rotary knobs are located in the head of the luminaire and can thus be reached from the work place.

Mobile and universal use

Roller stand: the mobile luminaire suits a polyvalent use in the most various medical areas.

Ceiling suspension and wall mounting: the possibility of mounting the luminaire on the ceiling or on a wall allows a universal use of the D^{med}® **saturn** LED, particularly in rooms requiring a high level of freedom of movement.



Safety / Standards

EN 60601

Medical electric equipment. This is the basic standard defining the design and safety requirements for medical electrical equipment.

EN 60601-1

General requirements, safety requirements.

EN 60601-2-41

Safety of operation, treatment and examination lights.

Dmed® saturn LED 30 C

TECHNICAL DATA

TREATMENT LIGHTS

FITTED WITH	1 x LED lamp
LUMINOUS POWER	55 000 Lux / 1,0 m
ILLUMINANCEFIELD 1,0 M	Ø 14-32 cm
COLOUR TEMPERATURE	approx. 3700 K / 4500 K / 5000 K
WORK EQUIPMENT	electronic converter
CONNECTED LOAD	100-240 V; 50/60 Hz
MAINS LEAD	appr. 3 m; special plug
LUMINAIRE BODY	aluminium powder-coated
WEIGHT (NET)	approx. 25.0 kg
POWER CONSUMPTION	approx. 30 W
USAGE	1 rotary knob with 3 levels (colour temperature), 2 rotary knobs (dimming and focusing)
TECHNOLOGY	single-pole secondary
BALANCE OF ARTICULATION JOINTS	spring (weight compensation)
CLASS OF PROTECTION	I
NORMS	EN 60601-1, EN 60601-2-41
SPECIAL FEATURES	3 color shades, 6 dimming levels, maintenance free, sterilisable grip, variable illumination field size
FASTENING	ceiling mount, intermediate ceiling adapter (on request), when mounting ceiling tube could be cut to length 30-120 cm
ORDER NUMBER	D15.071.000 - pure white - appr. 3 m; special plug

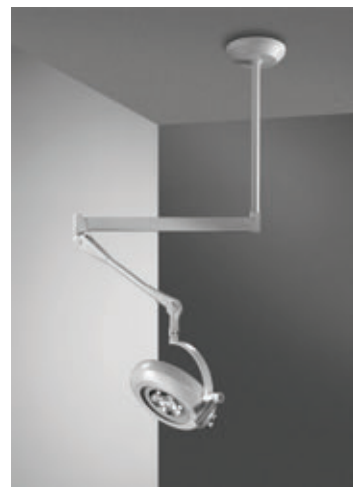

LIGHT DISTRIBUTION

TECHNICAL DRAWING

illuminancefield 14 cm

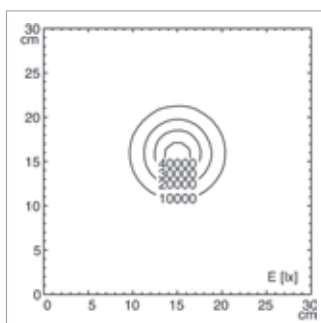
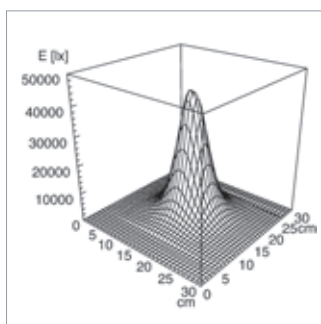

illuminancefield 32 cm

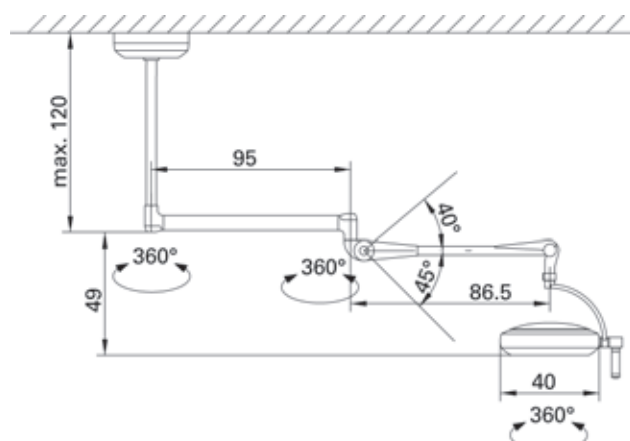
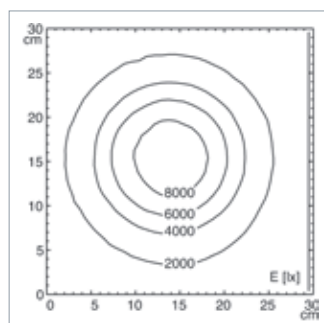
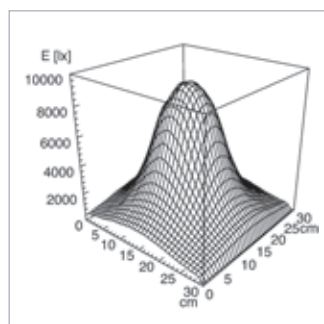

Dmed® saturn LED 30 W

TECHNICAL DATA

TREATMENT LIGHTS

FITTED WITH	1 x LED lamp
LUMINOUS POWER	55 000 Lux / 1,0 m
ILLUMINANCEFIELD 1,0 M	Ø 14-32 cm
COLOUR TEMPERATURE	approx. 3700 K / 4500 K / 5000 K
WORK EQUIPMENT	electronic converter
CONNECTED LOAD	100-240 V; 50/60 Hz
MAINS LEAD	appr. 3 m; special plug
LUMINAIRE BODY	aluminium powder-coated
WEIGHT (NET)	approx. 18.0 kg
POWER CONSUMPTION	approx. 30 W
USAGE	1 rotary knob with 3 levels (colour temperature), 2 rotary knobs (dimming and focusing)
TECHNOLOGY	single-pole secondary
BALANCE OF ARTICULATION JOINTS	spring (weight compensation)
CLASS OF PROTECTION	I
NORMS	EN 60601-1, EN 60601-2-41
SPECIAL FEATURES	3 color shades, 6 dimming levels, maintenance free, sterilisable grip, variable illumination field size
FASTENING	wall mount
ORDER NUMBER	D15.133.000 - pure white - appr. 3 m; special plug



LIGHT DISTRIBUTION

TECHNICAL DRAWING

illuminancefield 14 cm

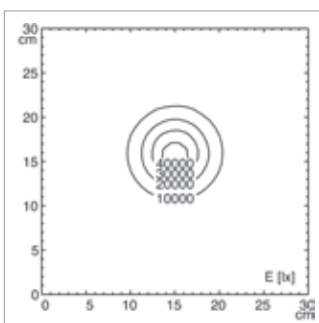
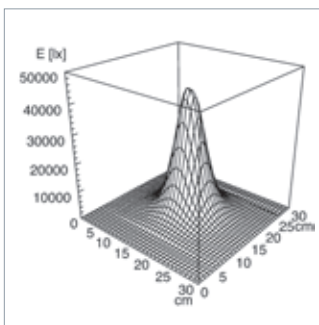

illuminancefield 32 cm

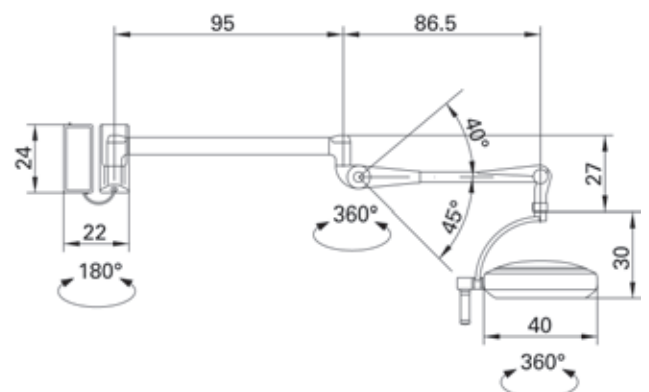
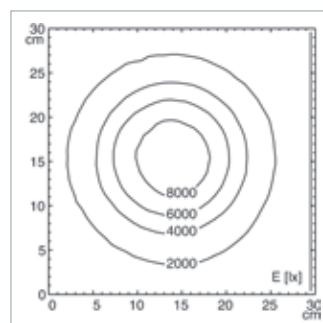
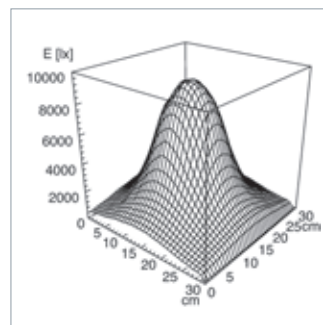

Dmed® saturn LED 30 F

TECHNICAL DATA

TREATMENT LIGHTS

FITTED WITH	1 x LED lamp
LUMINOUS POWER	55 000 Lux / 1,0 m
ILLUMINANCEFIELD 1,0 M	Ø 14-32 cm
COLOUR TEMPERATURE	approx. 3700 K / 4500 K / 5000 K
WORK EQUIPMENT	electronic converter
CONNECTED LOAD	100-240 V; 50/60 Hz
MAINS LEAD	approx. 3 m
LUMINAIRE BODY	aluminium powder-coated
WEIGHT (NET)	approx. 34.0 kg
POWER CONSUMPTION	approx. 30 W
USAGE	1 rotary knob with 3 levels (colour temperature), 2 rotary knobs (dimming and focusing)
TECHNOLOGY	single-pole secondary
BALANCE OF ARTICULATION JOINTS	spring (weight compensation)
CLASS OF PROTECTION	I
NORMS	EN 60601-1, EN 60601-2-41
SPECIAL FEATURES	3 color shades, 6 dimming levels, maintenance free, sterilisable grip, variable illumination field size
FASTENING	roller stand
ORDER NUMBER	D15.111.000 - pure white - Schuko D15.112.000 - pure white - CH D15.113.000 - pure white - UK



LIGHT DISTRIBUTION

TECHNICAL DRAWING

illuminancefield 14 cm

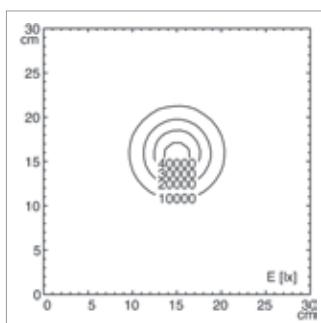
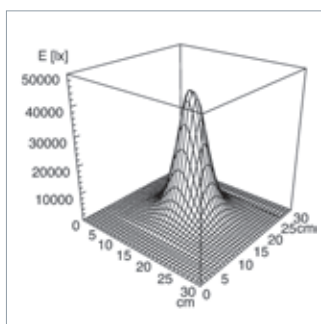

illuminancefield 32 cm

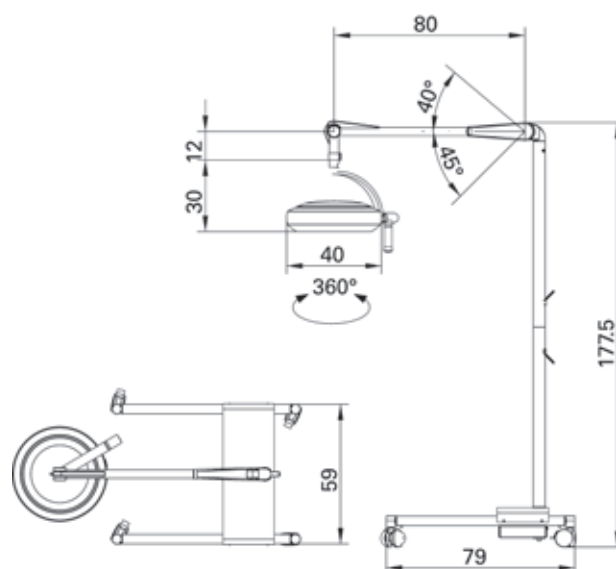
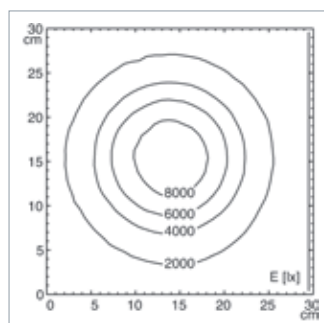
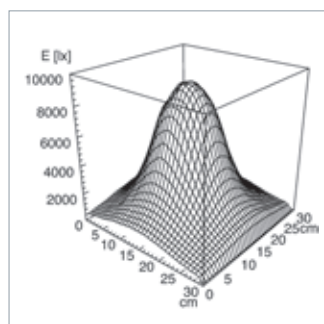

OWN DISTRIBUTORS

GERMANY

Herbert Waldmann GmbH & Co. KG
Postfach 5062
78057 Villingen-Schwenningen
Germany
Telephone +49 7720 601 100
Fax +49 7720 601 290
www.waldmann.com
info@waldmann.com

SWEDEN

Waldmann Ljusteknik AB
Skebokvarnsvägen 370
124 50 Bandhagen
Sweden
Telephone +46 8 990 350
Fax +46 8 991 609
www.waldmann.se
info-se@waldmann.com

SWITZERLAND

Waldmann Lichttechnik GmbH
Benkenstrasse 57
5024 Küttigen
Switzerland
Telephone +41 62 839 12 12
Fax +41 62 839 12 99
www.waldmann.com
info-ch@waldmann.com

USA

Waldmann Lighting Company
9, W. Century Drive
Wheeling, Illinois 60090
USA
Telephone +1 847 520 1060
Fax +1 847 520 1730
www.waldmannlighting.com
waldmann@waldmannlighting.com

AUSTRIA

Waldmann Lichttechnik Ges.m.b.H
Gewerbepark Wagram 7
4061 Pasching/Linz
Austria
Telephone +43 7229 67 400
Fax +43 7229 67 444
www.waldmann.com
info-at@waldmann.com

SINGAPORE

Waldmann Lighting Singapore Pte. Ltd.
Blk 168, Jalan Bukit Merah # 04-09 B
Connection 1, Tower 3
Singapore 150168
Singapore
Telephone +65 6275 8300
Fax +65 6275 8377
www.waldmann.com
sales-sg@waldmann.com

FRANCE

Waldmann Eclairage S.A.S
Z.I. - Rue de l'Embranchement
67116 Reichstett
France
Telephone +33 3 8820 95 88
Fax +33 3 8820 95 68
www.waldmann.com
info-fr@waldmann.com

CHINA

Waldmann Lighting (Shanghai) Co. Ltd.
Part A, No. Five Normative Workshop
199 Chang Jian Road, Baoshan
Shanghai, P.R.C. 200949
China
Telephone +86 21 5169 1799
Fax +86 21 3385 0032
www.waldmann.cn
s.lo@waldmann.com.cn

ITALY

Waldmann Illuminotecnica S.r.l.
Via della Pace, 18 A
20098 San Giuliano Milanese (MI)
Italy
Telephone +39 02 98 24 90 24
Fax +39 02 98 24 63 78
www.waldmann.com
info-it@waldmann.com

INDIA

Waldmann Lighting PVT. Ltd.
Plot No. 52
Udyog Vihar
Phase-VI, Sector-37
GURGAON-122011, Haryana
India
Telephone +91 124 412 1600
Fax +91 124 412 1611
www.waldmann.com
r.kumar@waldmann.com

NETHERLANDS

Waldmann BV
Lingewei 19
4004 LK Tiel
Netherlands
Telephone +31 344 631 019
Fax +31 344 627 856
www.waldmann.com
info-nl@waldmann.com

Derungs Licht AG

Hofmattstrasse 12
9200 Gossau
Switzerland
Telephone +41 71 388 11 66
Fax +41 71 388 11 77
www.derungslicht.com
mailbox@derungslicht.com

Further distribution partners you find at: www.derungslicht.com